



DEAERATING BOILER FEED UNITS

TYPE .005 DA-ST, .005 DA-ST-2T, .005 DA-CI & .005 DA-CI-2T

IOM MANUAL

Caution: This Unit is designed for atmospheric operation.
DO NOT Pressurize Receiver.

INSTALLATION, OPERATION AND MAINTENANCE (IOM) INFORMATION

PLEASE LEAVE THIS MANUAL FOR OWNER'S USE

SAFETY INSTRUCTIONS

Read this manual carefully to learn how to safely install and operate your pump. Throughout this manual there are a number of SAFETY HAZARDS that must be read and adhered to in order to prevent possible personal injury and/or damage to the equipment.

Three keywords, "DANGER", "WARNING", and "CAUTION", are used to indicate the potential severity of the hazard, and are preceded by a SAFETY ALERT SYMBOL. Failure to follow the safety-related instructions may result in a safety hazard.

DANGER Indicates an imminently hazardous situation which, if not avoided, *WILL* result in serious injury or death.

WARNING Indicates a potentially hazardous situation which, if not avoided, *COULD* result in serious injury or death.

CAUTION Indicates a potentially hazardous situation which, if not avoided, *MAY* result in minor or moderate injury.

THOROUGHLY REVIEW ALL INSTRUCTIONS AND WARNINGS PRIOR TO PERFORMING ANY WORK ON THIS PUMP.

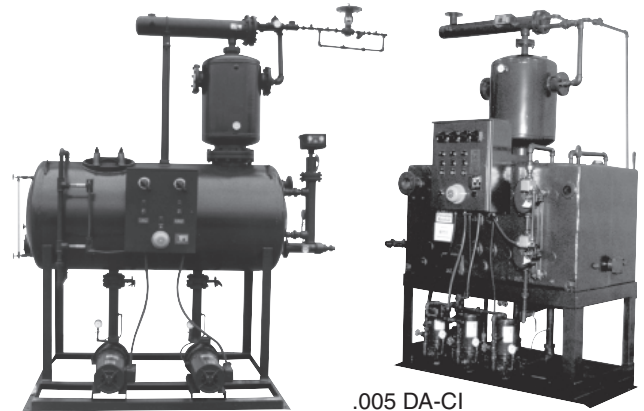

.005 DA-ST

.005 DA-CI

Introduction:

SHIPCO® .005 DA-ST, .005 DA-ST-2T, .005 DA-CI, and .005 DA-CI-2T De-aerating Boiler Feed Units are designed to remove the dissolved oxygen in boiler feed water to a level of .005cc/liter. Models .005 DA-ST, .005 DA-ST-2T have steel receivers; Models .005 DA-CI, and .005 DA-CI-2T have cast iron receivers. Units are fitted with water make-up assembly, spray manifold, vent condenser (shell & tube), direct injection steam heating assembly, boiler feed pumps, and an electrical control panel.

Standard receiver accessories usually include gauge glass assembly, dial thermometer, and suction tappings for pumps.

The unit may be furnished with one or more boiler feed pumps. Two or three pumps are the normal configuration.

Because pump installations are seldom identical, this manual cannot possibly provide detailed instructions and precautions for each specific application. Therefore, it is the responsibility and the duty of all personnel involved in the installation, operation and maintenance of the equipment to ensure that applications not addressed in this manual are performed only after establishing that neither operator safety nor pump integrity is compromised by the installation.

Pre-Installation Check:

Open all cartons and inspect for shipping damage. Report any damage to your shipping carrier or SHIPCO® sales representative immediately.

Always verify that the pump nameplate Voltage, Phase, and Horsepower ratings as well as Amps rating on motor match your control panel and power supply. Warranty does not cover damage caused by connecting pumps and controls to an incorrect power source (i.e., voltage and phase).

Site Inspection:



The unit should be of the proper size and capacity for the proposed installation. Refer to nameplate for rated capacities. Check motor voltage against available power supply.

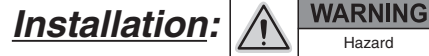

Electrical connections are to be made by a qualified electrician in accordance with the National Electrical Code (NEC) or the Canadian Electrical Code, as well as all national, state and local codes. Code questions should be directed to your local electrical inspector. Failure to follow electrical codes and OSHA safety standards may result in personal injury or equipment damage. Failure to follow manufacturer's installation instructions may result in electrical shock, fire hazard, personal injury or death, damaged equipment, provide unsatisfactory performance, and may void the manufacturer's warranty.

Operating personnel should be trained in the operation of the pump and any associated system.

Unit and/or Pump Location:



If pump and motor are operating at extremely high or low temperatures, insulate and ventilate as required.

Units are furnished with motors classified as either Open Drip Proof (ODP) or Totally Enclosed Fan Cooled (TEFC) motors. Controls can be

NEMA 1, NEMA 2, NEMA 4, etc. Other classifications are available upon request. Locate unit only in areas of the proper classification based on motor data and NEMA classifications of the equipment purchased.

A high ambient temperature *will cause* thermal overload protection to shut off the pump. To facilitate maintenance, place unit for easy access to all parts. Allow adequate space for servicing.

Seal Flush Line (or Bleed Line):



SHIPCO® pumps are manufactured with provisions for a seal flush line. This line helps prevent the pump from vapor binding and allows the pump to operate against a dead shut-off for periods of time without burning the seals. The bleed line must remain open.

If pumps run continuously, condensate temperature is 212°F or higher, and motor horsepower is 7½ or larger, then a bypass orifice is typically required.

Vent Connection:

Install a full sized vent to atmosphere from the receiver. **Do not** install any shut-off valves or other type of valves in the vent line. Do not plug vent to test system for leaks. Receiver is not made to be pressurized. The vent should be piped to an area suitable for a small steam plume (trace amounts).

Overflow:

Install overflow piping to drain.

Water Make-Up:

Provide a water supply (50 PSIG) to the modulating water make-up valve. Refer to IOM of make-up valve manufacturer for specific instructions. If a manual bypass was not included with the DA, one should be field installed.

The supply pressure to a mechanical make-up valve **MUST NOT** exceed 50 PSIG; if supply pressure is greater than 50 PSIG, then pressure **MUST** be reduced.

Steam Supply:

The unit is equipped with one direct injection heating assembly. Install the steam supply line to the main steam valve. Install the main steam valve per the manufacturer's instructions. Be sure to select the proper size for the required steam flow; a good rule of thumb is to install a steam line at least one pipe size larger than the inlet of the main steam valve. **Caution:** Do not restrict the valve by installing an undersized steam line.

Provide a shut-off valve in the steam supply line. A steam strainer and pipe union should be installed in the steam main, ahead of the steam regulator valve. The regulator should be adjusted to maintain a constant DA tank temperature of 212°F (at sea level). The regulator should be adjusted to maintain a small steam plume from the vent. To simplify adjusting the regulator, install a tee in the vent line under the roof line, in easy access. In the branch leg of the tee, install an observation 1" gate valve or ball valve. Open the valve to witness the slight trace of steam in the vent. Once the regulator valve has been set, close the observation valve.

Return Piping:

Properly pitched gravity return lines are piped to the unit as shown in the Typical Piping Diagram (Figure 2). An isolation valve should be installed for servicing. An inlet strainer should be installed to remove foreign material in the return line(s). Pumped returns should be piped to the spray manifold on the unit as shown in the Typical Piping Diagram. An isolation valve should be installed prior to the unit for servicing.

Suction Piping:



An isolation valve may be installed in the suction piping between the receiver and pump suction for servicing the pump. The valve will be sized to allow an adequate flow of water to meet the Net Positive Suction Head (NPSH) requirement of the pump.

Discharge Piping:

If the pump does not have a flanged discharge, install a *union* immediately beyond the pump discharge.

A spring-loaded check valve should be installed in the discharge piping near to the pump to prevent backflow into the unit. Next, a *manual flow control valve* (e.g., ball valve, globe valve, or steam cock) must be installed after the spring-loaded check valve and near to the pump discharge flange or union (see IOM for pump Model supplied with DA) to "balance the pump" (i.e., adjusting discharge flow of the pump to keep it running at the design operating conditions for flow rate and discharge pressure). A gate valve should not be used as a manual flow control valve. Note that some people refer to the term "balancing the pump" as either "throttling the pump" or "choking the pump".

If pump discharge is rated for 75 PSIG or greater, the pump may be equipped with an *automatic flow control valve* that functions as the balancing valve. When an automatic flow control valve is included, it must be installed in the discharge piping *immediately after the pump's discharge flange* or union *and before any other valves* (see IOM for pump Model supplied with DA). The automatic flow control valve is used to set the pump at the design operating conditions to prevent motor overload and pump cavitations. Note that the sequence of piping when using an automatic flow control valve is different from the manual flow control valve piping.

Notes on Piping:

1. When installing the pump, if the discharge flange of the pump does not include a tapping for a discharge pressure gauge port, a gauge port should be installed in the discharge piping.
2. The piping should include isolation valves on both the suction and discharge sides of the pump and have a drain valve in the suction line.

When installing the suction and discharge connections to a threaded pump housing, a Teflon tape sealer or a high quality thread sealant is recommended.

For specific instructions on installation, operation and maintenance of pump/motor assemblies fitted to receiver, refer to IOM Manual for appropriate pump model depending on which pump model that the unit is furnished with (e.g., Model D Series, Model P Series, Model AW/ AWF/ AWF-B Series, etc.).

Electrical Wiring:

Units are furnished with single-phase or three-phase motors. Single-phase motors are usually furnished as dual 115/230/1/60. Three-phase motors are usually furnished as tri-voltage 208/230/460/3/60. Motors should be connected according to manufacturer's instructions for correct voltage.

If control panel is furnished, confirm that the nameplate data on the control panel[s] matches the supply current. If the nameplate data does not match the power source, consult factory.

Verify controls such as motor wiring, starter coils, transformers, etc., match the control voltages before installing. The secondary side of transformer is the control circuit.

Wire in accordance with the National Electrical Code, state and local codes where applicable. See typical wiring diagrams (Figure 2).

Single-phase drip proof motors up to and including 1 horsepower have built-in thermal overload protection. But, the amp draw on most boiler feed level controls can handle only the amp draw of a 1/3 horsepower, single-phase motor. An electrical control panel is required for all other power sources and horsepower motors.

Short Circuit Protection:

According to the National Electrical Code, branch circuit over-current protection must be provided for each contactor or starter. The following table is provided as a guide. **DO NOT EXCEED MAXIMUM PROTECTIVE DEVICE RATINGS.** (See Figure 2.)

NOTE: Bleed line shut-off valve MUST remain open unless pump is being serviced.

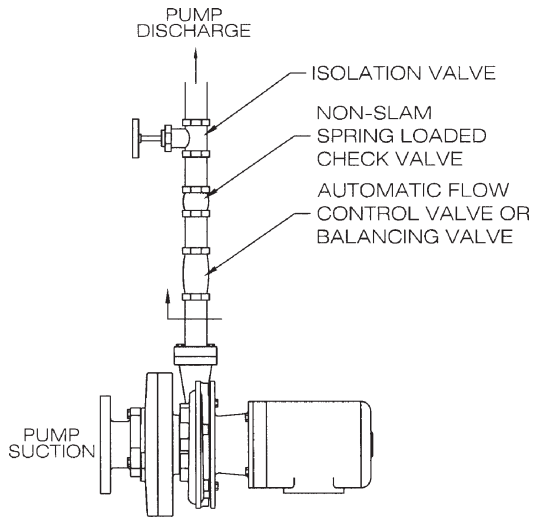

TYPICAL PIPING DIAGRAM FOR RECEIVER
 Refer to Discharge Piping Diagram for pump discharge to boiler piping arrangement.
FIGURE 1

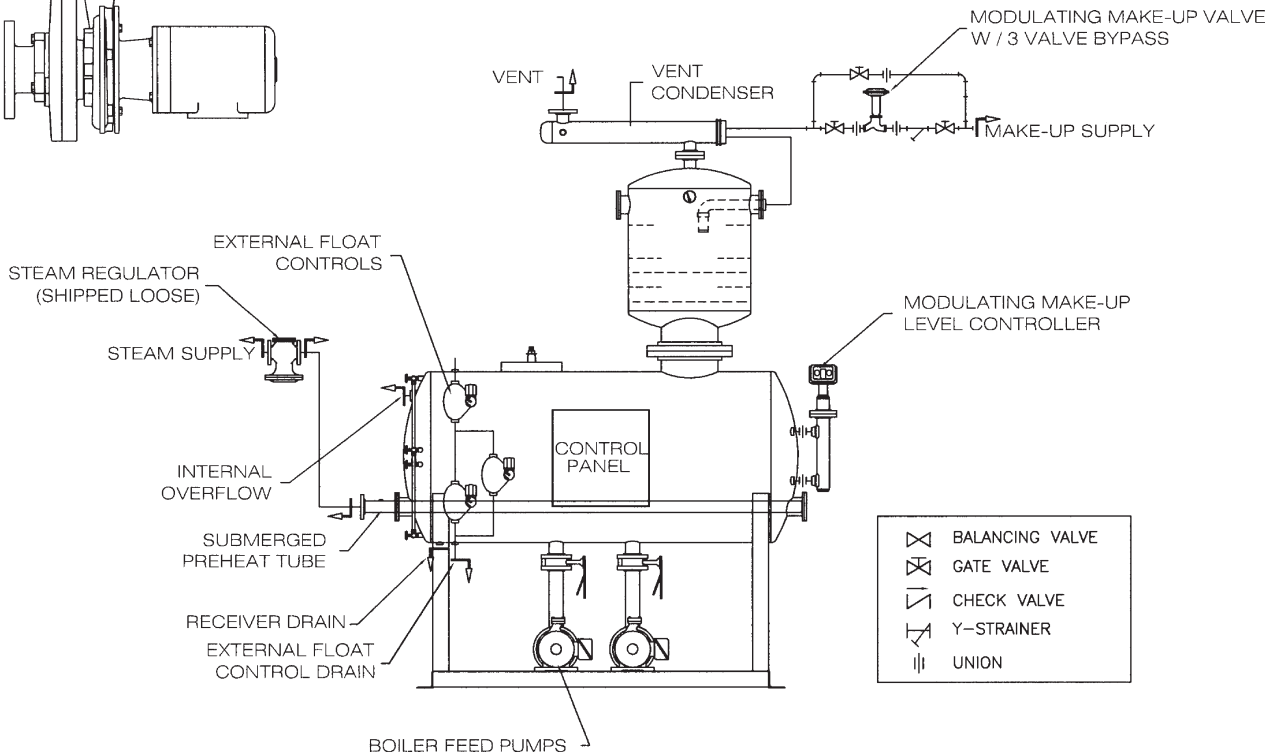

WARNING: The manufacturer will not be liable for any malfunction, damage, or destruction of the equipment if the equipment is not installed properly or is not installed by professionals, licensed and registered as required. Failure to follow and install the equipment according to job specific drawings, made by professionals who are licensed and registered as required and are familiar with the equipment, and failure to have the equipment installed by professionals, who are licensed and registered as required, in accordance with local, state, and federal codes will void all warranties and will void any liability upon the manufacturer. In addition, all warranties, including warranties of merchantability and fitness for a particular purpose are null and void for failure to follow job specific drawings made by professionals who are licensed and registered as required and are familiar with the equipment, and failure to have the equipment installed by professionals, who are licensed and registered as required, in accordance with local, state, and federal codes.

| Maximum HP Maximum Volts | | | | | NEMA Size | Maximum Voltage | Class K5 or R Fuse (Ampere) | Class K1 or J Fuse (Ampere) | Inverse-Time Circuit Breaker (Ampere) |
|-----------------------------|------|-------------|-------|------|--------------|--------------------|--------------------------------------|--------------------------------------|--|
| Single Phase | | Three Phase | | | | | | | |
| 115v | 230v | 208v | 250v | 600v | | | | | |
| 1/3 | 1 | 1 1/2 | 1 1/2 | 2 | 00 | 600 | 10 | 15 | 15 |
| | | | | | | 250 | 12 | 15 | 15 |
| 1 | 2 | 3 | 3 | 5 | 0 | 600 | 20 | 30 | 20 |
| | | | | | | 250 | 25 | 30 | 35 |
| 2 | 3 | 7 1/2 | 7 1/2 | 10 | 1 | 600 | 30 | 60 | 40 |
| | | | | | | 250 | 40 | 60 | 60 |
| - | - | 10 | 15 | 25 | 2 | 600 | 60 | 100 | 80 |
| | | | | | | 250 | 60 | 100 | 90 |
| - | - | 25 | 30 | 50 | 3 | 600 | 100 | 200 | 125 |
| | | | | | | 250 | 125 | 200 | 150 |

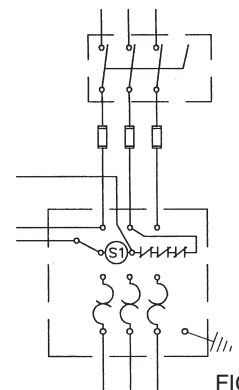

FIGURE 2

Boiler Level Controls:

Follow boiler and control manufacturer's recommendations for inter-connecting wiring of controls. Codes will require cut-off and safety controls in addition to the required pump controls.

PUTTING THE DA AND PUMPS INTO SERVICE:

- A. Inspect the installation to insure the units are installed in accordance with the manufacturer's IOMs and any and all State and Local codes.
- B. Check the electrical panel nameplate for the proper incoming line voltage. Compare this to the actual incoming line voltage. If they are the same you may proceed. If they are different, consult the factory for any changes required for the actual line voltage.
- C. Flush unit to drain to remove any debris from total system (i.e., pipes, radiators, receivers, etc.). Make sure all debris has been removed from inlet strainer after start-up of system. Reinstall drain plug.
- D. Remove shipping brackets on all the external float switches. Per instructions on tag attached to float switch, remove shipping bracket (See Figure 3) from each float switch as per manufacturer's instructions. The float switches have been factory set for maximum capacity of the receiver. Should an alternate setting be required, refer to the float switch manufacturer's instructions. If needed, reference Technical Articles section on the SHIPCO® website (www.shipcopumps.com) for detailed instructions on how to adjust a float switch (*Adjusting a Nema 1 Square-D, 9037 Series Float Switch*).
- E. Check to insure the available steam pressure to the regulator[s] matches the design operating conditions.
- F. Prime the unit by filling the receiver approximately one-third (1/3) full of water with the automatic make-up. If two tank system with a surge tank, add water to the surge tank via the solenoid valve/float switch; otherwise add water into the DA tank and skip to **Step L**.
- G. As the unit is filling, check the operation of all floats on the surge tank.
- H. Prime each transfer pump. Refer to IOM Manual for particular pump model supplied with unit.
- I. If two tank design with surge tank, turn the power on to the transfer pumps. Bump start each pump to check pump rotation. Correct any pump rotation problems that are found. **DO NOT RUN PUMPS DRY.** Running pumps dry will damage mechanical seals.
- J. Adjust the throttling valve (closed) installed in pump discharge to balance each transfer to the design operating conditions. If pump[s] furnished with automatic flow control valves (refer to Discharge Piping Section above).
- K. After fully checking out the DA, start a transfer pump on surge tank and allow it to fill the DA.
- L. While the DA is filling check the float switch operations on the DA to insure they are right. When the tank is about 1/3–1/2 full, stop filling the DA.
- M. Slowly open the main isolating valve to the steam regulator. Do this in stages.
- N. Gradually bring the DA up to temperature of 212°F at sea level.
- O. Adjust the steam regulator, per the IOM from regulator manufacturer, to set the temperature/pressure of the DA.
- P. Prime each boiler feed pump. Refer to IOM Manual for particular pump model supplied with unit.
- Q. Once DA is up to temperature, bump start each boiler feed pump to check pump rotation. Correct any pump rotation problems that are found. **DO NOT RUN PUMPS DRY.** Running pumps dry will damage mechanical seals.
- R. Adjust the throttling valve (closed) installed in pump discharge to balance each transfer to the design operating conditions. If pump[s] furnished with automatic flow control valves (refer to Discharge Piping Section above). If boiler feed pumps are fitted with an automatic balancing valve, pumps should balance themselves within the operating range of the valve.

- S. *Motor Lubrication:* If the pump is a close-coupled centrifugal unit, the pump has no internal bearings. Refer to IOM Manual for appropriate pump model for additional information.
- T. **Bleed line shut-off valve and bypass line (if present) MUST REMAIN OPEN unless pump is being serviced.**
- U. **Should pump sound noisy, it may not be operating at design conditions. Adjust throttling valve to operate at the proper discharge pressure.**

Special Startup Considerations:

- a. *Filling "Cold" Boiler With Feed Pumps:* When centrifugal pumps are being used on either a boiler feed unit or deaerator, the pumps should not be used to fill a high pressure (i.e., operating pressure of 15 PSIG or higher) with water when the boiler is cold. When boiler is started up, there is no back-pressure on the pump. Without any back-pressure, the pump will "run out the curve," causing pump cavitations that will severely damage the pump.

However, if boiler feeds are used to fill a boiler, then the pump must be manually balanced to keep the pump at the design operating conditions and prevent pump cavitations. Manual balancing is required even if the pump is fitted with an automatic flow control valve. The automatic flow control valve is rated for a particular pressure range that allows the operating pressure in the boiler to fluctuate. However, the difference in operating pressure between boiler startup and the design operating pressure typically will exceed the pressure range of the automatic flow control valve, rendering it ineffective at startup.
- b. *Chemical Injection:* Any chemicals injected into the steam system should be added after the pumps—preferably into the pump discharge piping. Otherwise, chemical residuals will contribute to the premature failure of a pump's mechanical seal. This scenario frequently occurs on boiler feed and deaerator applications.
- c. *Freezing Conditions:* Avoid freezing conditions after receiver of unit has been filled with condensate. Frozen water may cause the suction housing to crack.

Float Switches:

Float switch and/or displacer switches, standard or proportional, are provided to meet system requirements.

Floats are locked in place during shipment by a shipping bracket to prevent damage. Shipping brackets must be removed before startup. Check factory settings.

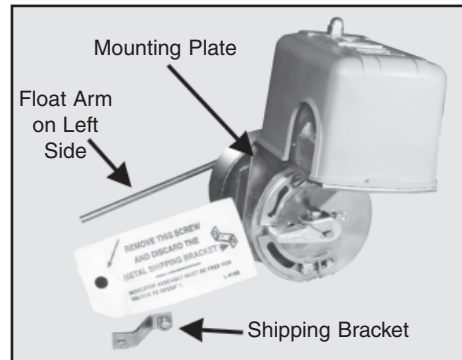

FIGURE 3—Float Switch

WARNING!

Switch is shipped with a bracket attached to the mounting plate to prevent the float from moving in the tank during shipment. When installing the unit, this bracket, clearly marked with a tag, **MUST** be removed for float switch to operate.

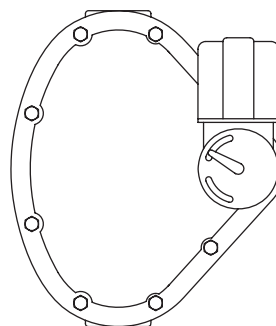

FIGURE 4
External Float
Switch Assembly



Switch is shipped with a bracket attached to the mounting plate to prevent the float from moving in the tank during shipment. When installing the unit, this bracket, clearly marked with a tag, **MUST** be removed for float switch to operate.

The pressure limit within the closed tank **must not exceed 50 pounds per square inch (psi)**.

DESCRIPTION OF OPERATION

SHIPCO® .005 DA-ST, .005 DA-ST-2T, .005 DA-CI, and .005 DA-CI-2T Deaerating Boiler Feed Units are designed for atmospheric operation using a spray/tray system. The unit liberates the dissolved oxygen and carbon dioxide.

On a two-tank design (2T), the returns are piped to the boiler feed/surge tank. The returns and makeup are blended together in the boiler feed/surge tank and then piped through a *modulating transfer valve* on the DA entering the deaeration area of the DA through a spring loaded spray nozzle.

On a single-tank design, the returns and makeup are piped through a *modulating makeup valve* on the DA and enter the deaeration area of the DA through a spring loaded spray nozzle.

Below the waterline is a preheat tube constantly injecting steam into the condensate to maintain design operating temperature. The steam passes up through the condensate in the holding tank over the cascade baffles in the deaeration area. The steam and escaping gases heat the incoming makeup water as the gases escape through the vent condenser.

MECHANICAL SEAL REPLACEMENT INSTRUCTIONS FOR PUMPS

When it is necessary to replace a mechanical seal, refer to the procedures in the Installation, Operation, and Maintenance Manual (IOM) for appropriate pump model (e.g., Model D Series, Model P Series, Model AW/AWF/AWF-B etc.), depending on what pump model was furnished.

Note: Seals will be damaged if operated dry.

TROUBLESHOOTING CHECKLIST

PUMP WILL NOT RUN

1. Power supply has been interrupted. Disconnect switch is open or selector switch improperly positioned.
2. Improper voltage supplied to motor. Check voltage and wiring with motor characteristics.
3. Incorrect starter coil for power supply.
4. Overload relays in starter have tripped out and must be reset. Ambient temperature may be excessive.
5. Wiring to power source is incorrect or connections may be loose.
6. Control signals are for pump to be "off."

PUMP GPM CAPACITY IS REDUCED

1. Pump is running backwards. Rotation should be clockwise looking down upon motor toward the pump. Rotation of three-phase motors can be corrected by interchanging any 2 of the 3 wires. (*Note: A qualified electrician should perform any electrical service.*)
2. Pump is **not throttled** to the design condition for the pump.
3. Total pressure at pump discharge is greater than that which the pump was designed for. Check pressure requirements, which include system back pressure, and friction and static head.
4. Excessive suction lift, incorrect piping or undersized piping from the pump.
5. A valve in the pump suction line or discharge line is closed or throttled too much. Check valve in the pump discharge piping is installed backwards.

6. The impeller eye is blocked with trash or debris.
7. Pump is undersized for the system.
8. A strainer is dirty, causing a reduction in flow.
9. Pump has lost its prime. Release trapped air in the pump and reprime.
10. Steam traps are blowing through, causing the condensate to return at excessive temperatures. Depending on the unit and type of pump furnished, this could greatly reduce the capacity of the pump below its stated rating. Traps should be repaired or replaced.

EXCESSIVE PUMP NOISE

1. Pump is running backwards. Check rotation by bumping the motor. Rotation should be clockwise while looking down at the rear of the motor.
2. Pump is working against a lower pressure than it was designed for. (The pump is not balanced or throttled.) Install a balancing valve, plug cock or steam cock in the discharge line following the gate valve. **Do not use a gate valve for balancing the pump. The seats in the valve will wear over time, causing the valve to lose its design condition point.** Throttle the balancing valve until the operating pressure at the pump discharge approaches the rated pump pressure.
3. Magnetic hum or bearing noise in motor. Consult the motor manufacturer's authorized service technician.
4. Starter chatters. Trouble is caused by low line voltage, poor connections, defective starter coil, or burned contacts.
5. Excessive ambient temperature. Correct the system conditions.
6. Entrained air. Release the trapped air pocket.

SYSTEM IS NOISY

1. The return piping is sized too small to drain properly.
2. A defective trap is holding condensate in steam supply line.
3. Banging in the steam mains is usually caused by steam bubbles "imploding" in condensate lying in low points in lines. These situations can be resolved by dripping low points, providing proper supports for the piping or by repitching the lines.
4. Steam mains and/or risers improperly dripped: where there is a rise in the steam main, or where it branches off into a riser, a drip trap must be installed in the drain line.
5. A defective check valve is permitting steam to vent through the pump into the boiler feed tank.

UNIT IS OVERFLOWING

1. Receiver is sized too small to accommodate surges in the system.
2. City water make-up valve is leaking.
3. City water make-up valve stuck open or float switch is set too high.

Representative Servicing:

If trouble occurs that cannot be rectified, contact your local SHIPCO® representative who will need the following information in order to provide assistance:

1. Provide all information on pump and motor from SHIPCO® name-plate (see example).
2. Suction and discharge pipe pressure gauge readings.
3. Ampere draw of the motor.
4. A sketch of the pump hook-up and piping.

| | | | |
|------------------|------------|---|-----------------|
| UNIT MODEL | | [REDACTED] | |
| MANUFACTURED BY | | P.O. BOX 279, SHIPPENSBURG, PA 17257 | |
| SHIPCO® PUMPS | | PHONE: (717) 532-7321 • FAX: (717) 532-7704 | |
| | | WWW.SHIPCOPUMPS.COM | |
| RATED | [REDACTED] | GPM @ | [REDACTED] PSIG |
| MOTOR HP | [REDACTED] | VOLTAGE | [REDACTED] |
| UNIT SERIAL NO. | | [REDACTED] | |
| PUMP TYPE | | [REDACTED] | |

Notes/Comments

Notes/Comments

TERMS AND CONDITIONS OF SALE

AGREEMENT

By entering your order or requesting a quote, you confirm that the following terms and conditions of sale are the legal agreement governing your purchase, and that no changes or additional or different terms will apply unless you have previously established a different written contract for these purchases with Shippensburg Pump Company, Inc., hereafter referred to as the Seller.

ORDER ACCEPTANCE

All orders are subject to acceptance by Seller at its general office in Shippensburg, Pennsylvania. Acceptance will be evidenced by Seller issuing its Sales Acknowledgement Form. The Sales Acknowledgement Form, together with any documents incorporated therein, shall constitute the entire agreement and may not be changed except in writing signed by Seller and Buyer. Publication and circulation of current price lists, catalogues and related literature by Seller shall not be deemed an offer to sell, but rather an invitation for offers to buy. Acceptance by Seller of the Buyer's order is expressly limited to the Terms and Conditions stated herein; any additional, inconsistent or different terms and conditions contained in the Buyer's purchase order or other documents supplied by Buyer are expressly rejected.

PAYMENT TERMS—PRICES

Payment terms are as follows: If the Buyer is a Credit Card Customer, the Buyer agrees to pay at the time of purchase the price, shipping and handling charges, taxes and duties quoted by the Seller. If the Buyer is an Account Holder, the Buyer agrees to pay invoices with payment terms of net thirty (30) days after date of invoice unless otherwise specifically agreed to in writing. If the Seller believes that the Buyer's financial condition requires it, the Seller reserves the right to require full or partial payment prior to manufacture or shipment. If the Buyer fails to make any payment when due, (1) the seller reserves the right to suspend performance and the Buyer agrees that any charges incurred prior to the suspension will be assessed to the Buyer and payable to the Seller; (2) the Buyer further agrees to pay a charge on the amount past due at the rate of 1½% per month (18% per year) or the maximum lawful rate, whichever is less. In the event of non-payment, the Buyer agrees to pay the Seller reasonable attorney's fees and court costs, if any incurred by the Seller to collect payment and interest charges. These terms shall apply to partial, as well as complete shipments of Product. Published prices are subject to change without notice and the right is reserved to invoice at prevailing prices at time of shipment unless otherwise specifically agreed to in writing. All quotations are conditional on 30 days acceptance unless stipulated otherwise in writing and to approved credit rating or reference, otherwise payment terms are cash with order or C.O.D.

DELIVERY—DELAYS

Shipping dates represent estimates only and are based on projected production schedules and commitments by suppliers. Seller shall not be liable for failure or delay in manufacturing or shipping Products, nor shall such failure or delay constitute grounds for cancellation if such failure or delay is directly or indirectly due to shortages of fuel or energy; acts of omissions of the Buyer; acts of God; war, riot, civil disturbances; labor difficulties; accident; inability to reasonably obtain materials; acts of transportation companies; or other causes of any kind whatever beyond the control of Seller. In the event of such delays, Seller reserves the right to make adjustments in price and delivery schedules.

FREIGHT TERMS

Prices are f.o.b. factory unless otherwise stated. Seller's responsibility ceases upon delivery to the transportation company at shipping point. It is the Buyer's responsibility to examine shipment upon arrival to ascertain if in good order. Any shortage or damage claims must be pursued by the Buyer. All weights shown on price sheets and literature are approximate. All packaging is standard domestic boxing, slat and wire crating and/or skidding. An additional charge will be made for full wooden crating or special packaging when specified on the order.

Seller will make every effort to consolidate orders and backorders wherever possible. Seller will not be responsible for excess charges due to their inability to consolidate shipments.

When requested by Buyer, shipments may be routed using premium carriers such as express or airfreight or the Buyer may specify the method or route of shipment. In such cases the shipment will be made on a "collect" basis and where applicable the freight allowance will appear as a separate line item on the product invoice, Seller reserves the right to select the transportation company where freight is allowed.

TAXES

In addition to the price stated, the amount of any present or future sales, use, excise or other similar tax applicable to the production, sale, use or transportation of the Products shall be paid by Buyer. In lieu of paying such taxes to Seller, Buyer may furnish Seller a Tax Exemption Certificate or Certificates acceptable to appropriate taxing authorities at any time prior to Seller's shipment of the Products.

CANCELLATIONS

Any order placed with Seller may be cancelled by the Buyer only upon payment of reasonable cancellation charges that shall include but not be limited to expenses already incurred, as well as material and labor commitments made by Seller.

SHIPMENT—TITLE—RISK OF LOSS

Shipment terms are f.o.b. Seller's facility, unless otherwise specifically agreed to in writing. Notwithstanding the granting of any allowances for shipping, title to and risk of loss for Products will pass to the Buyer when delivered to the Common carrier at the Seller's facility.

BACK CHARGES

All invoices shall be due and payable when submitted for payment in accordance with the provision entitled "Payment Terms—Prices." No withholding of funds, back charges, or credits against amounts otherwise due Seller will be permitted unless specifically agreed to in writing by Seller. Settlement of any amounts due Buyer will be negotiated as separate items and not as offsets against amounts otherwise due Seller from Buyer for Products sold hereunder.

RETURNED GOODS

Unused material of current manufacture can only be returned for credit with the written consent of Seller, under return goods policies existing at the date of the return. Products that are obsolete or made to special order are not returnable.

PATENT INDEMNITY

a. Patent Indemnity by Seller to Buyer

Seller agrees to indemnify and hold harmless the Buyer from and against all legal expenses which may be incurred, as well as all damages and costs (except all consequential and special damages and costs) which may be finally assessed against Buyer in any action for infringement of any United States Letters Patent by the Products delivered to Buyer hereunder; provided that the Buyer shall give Seller prompt written notice of any action, claim or threat of patent infringement suit, either oral or written, or of the commencement of any patent infringement suit against Buyer relating to Products sold by Seller to Buyer hereunder; and provided Buyer shall give Seller opportunity to elect to take over, settle, or defend any such claim, action or suit through counsel of Seller's own choice and under

its sole direction, and at its sole expense, and provided that in the event Seller elects to take over, defend or settle same. Buyer will make available to Seller all defenses against any such claim, action, suit or proceeding known to or available to Buyer; and provided further that Seller shall have the right to substitute for any such Product or any part thereof claiming to infringe the patent right of others, non-infringing Products which will give equally good service. If the use of any such Product or any part thereof should be enjoined, Seller shall have the right at its own expense, to take any of the following courses of action:

- i. To procure for Buyer the right to continue using such Product;
- ii. To replace said Product with a non-infringing Product;
- iii. To modify the Product so that it becomes non-infringing; or
- iv. To remove said Product and refund the purchase price, transportation costs and installation costs thereof.

b. Limitation

The foregoing provisions as to patent protection by Seller to Buyer shall not apply to any of the following:

- i. To any Product manufactured to the design or specification furnished by the Buyer;
- ii. To orders for special non-commercial Products which Seller has not sold or offered for sale to the public on the open commercial market;
- iii. To any infringement occasioned by modification by Buyer of any Product without Seller's written consent, or any infringement arising from the use of a Product with any adjunct or device added by the Buyer without Seller's written permission.

c. Patent Indemnity by Buyer to Seller

To the extent that Products delivered hereunder are manufactured pursuant to detailed designs furnished by Buyer, Buyer agrees to indemnify Seller and hold Seller harmless from all legal expenses which may be incurred, as well as all damages and costs, which may finally be assessed against Seller in any action for infringement of any United States Letters Patent by such Products delivered hereunder. Seller agrees to promptly inform the Buyer of any claim for liability made against Seller with respect to such Products and Seller agrees to cooperate with the Buyer in every way reasonably available to facilitate the defense against any such claim.

GOVERNING LAW

The validity, interpretation and performance of any order shall be governed by the Uniform Commercial Code ("UCC") as adopted by the state in which the Products are manufactured by Seller.

WARRANTY AND LIMITATION OF LIABILITY

Seller warrants for a period of eighteen (18) months from date of shipment from its factory or one (1) year from date of installation, whichever occurs first, that all Products furnished by it are free from defects in materials and workmanship.

Seller's liability for any breach of this Warranty shall be limited solely to replacement or repair, at the sole option of Seller, of any part or parts found to be defective during the Warranty period providing the Product is properly installed and is being used as originally intended. Buyer must notify Seller of any breach of this Warranty within the aforementioned Warranty period; defective parts must be shipped by Buyer to Seller, transportation charges prepaid.

IT IS EXPRESSLY AGREED THAT THIS SHALL BE THE SOLE AND EXCLUSIVE REMEDY OF THE BUYER. UNDER NO CIRCUMSTANCES SHALL SELLER BE LIABLE FOR ANY COSTS, LOSS, EXPENSE, DAMAGES, SPECIAL DAMAGES, INCIDENTAL DAMAGES OR CONSEQUENTIAL DAMAGES ARISING DIRECTLY OR INDIRECTLY FROM THE DESIGN, MANUFACTURE, SALE, USE OR REPAIR OF THE PRODUCT WHETHER BASED UPON WARRANTY, CONTRACT, NEGLIGENCE OR STRICT LIABILITY. IN NO EVENT WILL LIABILITY EXCEED THE PURCHASE PRICE OF THE PRODUCT.

THE WARRANTY AND LIMITS OF LIABILITY CONTAINED HEREIN ARE IN LIEU OF ALL OTHER WARRANTIES AND LIABILITIES, EXPRESSED OR IMPLIED. ALL IMPLIED WARRANTIES OF MERCHANTABILITY AND FITNESS FOR A PARTICULAR PURPOSE ARE HEREBY DISCLAIMED BY SELLER AND EXCLUDED FROM THIS WARRANTY.

Seller neither assumes, nor authorizes any person to assume for it, any other Warranty obligation in connection with the sale of the Product. This Warranty shall not apply to any Product or parts of Products which (a) have been repaired or altered outside of Seller's facilities; or (b) have been modified or damaged through misuse, abuse, accident, neglect or mishandling by Purchaser or Purchaser's customer, erroneous voltage, modification, acts of God, or any other act not specifically stated; or (c) have been used in a manner contrary to Seller's instructions.

Products covered by this warranty are for the intended uses as described in the corresponding seller's instructions. Before using for any other application, user shall determine the suitability of the product for its intended use and user assumes all risk and liability in connection therewith.

No oral statement made by the seller, its agents, employees, or other representatives, concerning the product, its value, description, condition, design, specifications, performance, capability, durability, adaptability, or accuracy, shall be relied upon by the purchaser and is specifically and expressly excluded and invalidated as the basis for any bargain or warranty.

In the case of Products not manufactured by Seller, there is no Warranty from Seller, but Seller will extend to the Buyer any Warranty of Seller's supplier of such Products.

FORCE MAJEURE

Seller shall have no liability in respect of failure to deliver or perform, or delay in delivering or performing any obligations due to causes such as acts of omissions of Buyer; acts of God, fire, flood, war and civil disturbances; riot, acts of governments, currency restrictions, labor shortages or disputes, unavailability of materials, fuel, power, energy or transportation facilities, failures of suppliers or subcontractors to deliver on time and every other circumstance outside the reasonable control of Seller.

MODIFICATIONS

Unless otherwise provided, Seller reserves the right to modify the specifications of Products ordered by the Buyer providing that the modification will not materially affect the performance.

STORAGE CHARGE

If Buyer is unable to accept products in accordance with the applicable shipping schedule then Seller may arrange to store ordered Products and the cost of storage will be charged to Buyer.

ENTIRE CONTRACT

These provisions constitute all the terms and conditions agreed upon by the parties and shall replace and supersede any provisions on the face and reverse side of Purchase Order and any attachment thereto, or any prior general agreement inconsistent with the provisions hereof except that orders by Representatives with whom Seller has an Agreement shall be subject to the provisions of the Agreement. No modification hereof shall be valid unless in writing and duly signed by a person authorized by Seller. The provisions hereof shall not be modified by any usage of trade, or any course of prior dealings or acquiescence in any course of performance.